

Computer Networks

Introduction To Computer Networks

Today the world scenario is changing. Data Communication and network have changed the way business and other daily affair works. Now, they rely on computer networks and internet. A set of devices often mentioned as nodes connected by media link is called a Network. A node can be a device which is capable of sending or receiving data generated by other nodes on the network like a computer, printer etc. These links connecting the devices are called Communication channels.

Computer network is a telecommunication channel through which we can share our data. It is also called data network. The best example of computer network is Internet. Computer network does not mean a system with control unit and other systems as its slave. It is called a distributed system

A network must be able to meet certain criteria, these are mentioned below:

1. Performance
2. Reliability
3. Scalability

Performance

It can be measured in following ways :

- **Transit time** : It is the time taken to travel a message from one device to another.
- **Response time** : It is defined as the time elapsed between enquiry and response.

Other ways to measure performance are :

1. Efficiency of software
2. Number of users
3. Capability of connected hardware

Reliability

It decides the frequency at which network failure take place. More the failures are, less is the network's reliability.

Security

It refers to the protection of data from the unauthorised user or access. While travelling through network, data passes many layers of network, and data can be traced if attempted. Hence security is also a very important characteristic for Networks.

Properties of Good Network

1. **Interpersonal Communication** : We can communicate with each other efficiently and easily example emails, chat rooms, video conferencing etc.
2. **Resources can be shared** : We can use the resources provided by network such as printers etc.
3. **Sharing files, data** : Authorised users are allowed to share the files on the network.

Basic Communication Model

Communication model is used to exchange data between two parties. For example communication between a computer, server and telephone (through modem).

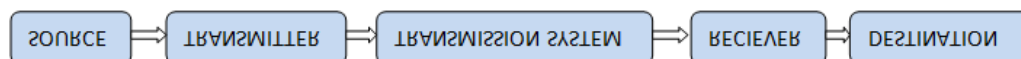

Source

Data to be transmitted is generated by this device, example: telephones, personal computers etc.

Transmitter

The data generated by the source system are not directly transmitted in the form they are generated. The transmitter transforms and encodes the information in such a form to produce electromagnetic waves or signals.

Transmission System

A transmission system can be a single transmission line or a complex network connecting source and destination.

Receiver

Receiver accepts the signal from the transmission system and converts it to a form which is easily managed by the destination device.

Destination

Destination receives the incoming data from the receiver.

Data Communication

The exchange of data between two devices through a transmission medium is Data Communication. The data is exchanged in the form of 0's and 1's. The transmission medium used is wire cable. For data communication to occur, the communication device must be part of a communication system. Data Communication has two types Local and Remote which are discussed below :

Local :

Local communication takes place when the communicating devices are in the same geographical area, same building, face-to-face between individuals etc.

Remote :

Remote communication takes place over a distance i.e. the devices are farther. Effectiveness of a Data Communication can be measured through the following features :

1. **Delivery** : Delivery should be done to the correct destination.
2. **Timeliness** : Delivery should be on time.
3. **Accuracy** : Data delivered should be accurate.

Components of Data Communication

1. **Message** : It is the information to be delivered.
2. **Sender** : Sender is the person who is sending the message.
3. **Receiver** : Receiver is the person to whom the message is to be delivered.

4. **Medium** : It is the medium through which message is to be sent for example modem.
5. **Protocol** : These are some set of rules which govern data communication.

Line Configuration in Computer Networks

Network is a connection made through connection links between two or more devices. Devices can be a computer, printer or any other device that is capable to send and receive data. There are two ways to connect the devices :

1. Point-to-Point connection
2. Multipoint connection

Point-To-Point Connection

It is a protocol which is used as a communication link between two devices. It is simple to establish. The most common example for Point-to-Point connection (PPP) is a computer connected by telephone line. We can connect the two devices by means of a pair of wires or using a microwave or satellite link.

Example: Point-to-Point connection between remote control and Television for changing the channels.

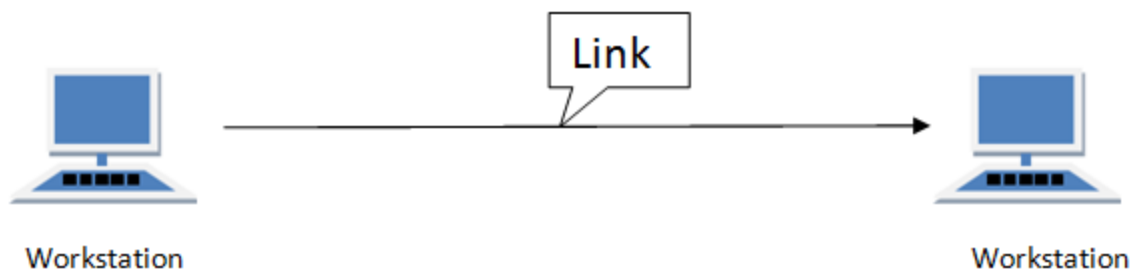

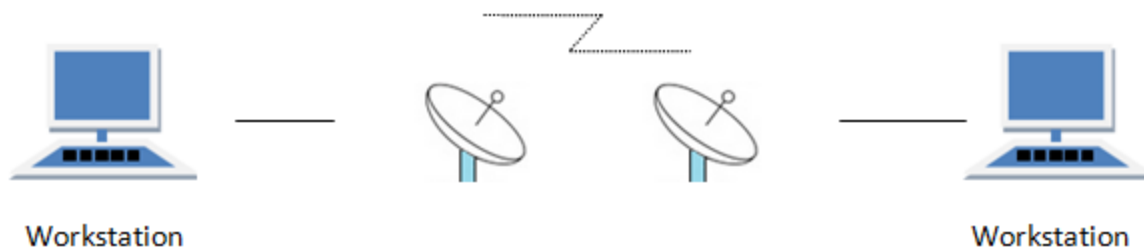

MultiPoint Connection

It is also called Multidrop configuration. In this connection two or more devices share a single link.

There are two kinds of Multipoint Connections :

- If the links are used simultaneously between many devices, then it is spatially shared line configuration.
- If user takes turns while using the link, then it is time shared (temporal) line configuration.

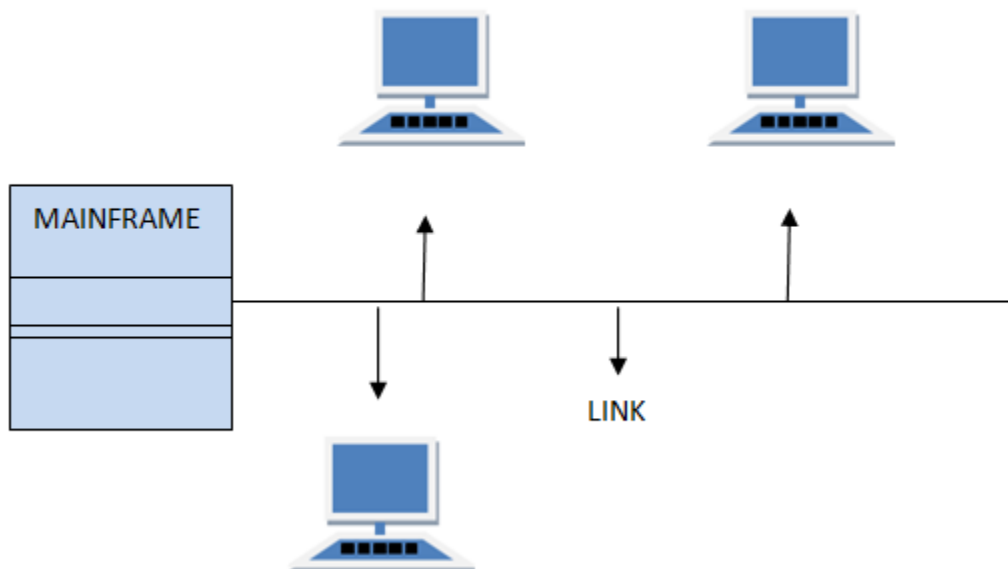

Types of Network Topology

Network Topology is the schematic description of a network arrangement, connecting various nodes(sender and receiver) through lines of connection.

BUS Topology

Bus topology is a network type in which every computer and network device is connected to single cable. When it has exactly two endpoints, then it is called **Linear Bus topology**.

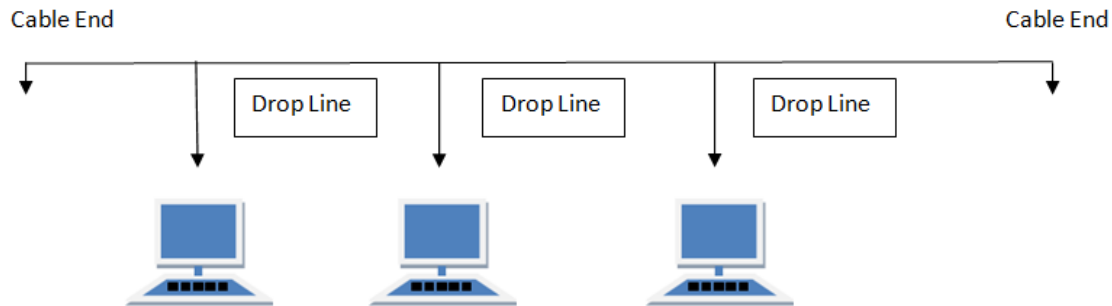

Features of Bus Topology

1. It transmits data only in one direction.
2. Every device is connected to a single cable

Advantages of Bus Topology

1. It is cost effective.
2. Cable required is least compared to other network topology.
3. Used in small networks.
4. It is easy to understand.
5. Easy to expand joining two cables together.

Disadvantages of Bus Topology

1. Cables fails then whole network fails.
2. If network traffic is heavy or nodes are more the performance of the network decreases.
3. Cable has a limited length.
4. It is slower than the ring topology.

RING Topology

It is called ring topology because it forms a ring as each computer is connected to another computer, with the last one connected to the first. Exactly two neighbours for each device.

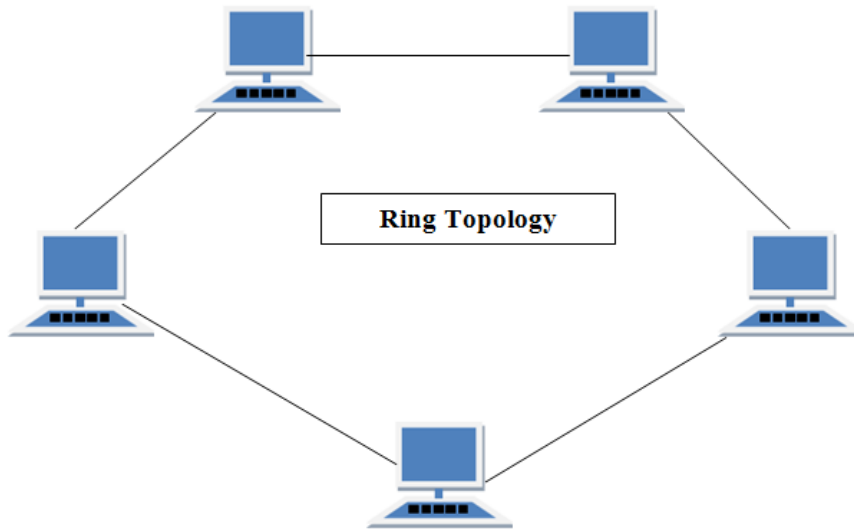

Features of Ring Topology

1. A number of repeaters are used for Ring topology with large number of nodes, because if someone wants to send some data to the last node in the ring topology with 100 nodes, then the data will have to pass through 99 nodes to reach the 100th node. Hence to prevent data loss repeaters are used in the network.
2. The transmission is unidirectional, but it can be made bidirectional by having 2 connections between each Network Node, it is called **Dual Ring Topology**.
3. In Dual Ring Topology, two ring networks are formed, and data flow is in opposite direction in them. Also, if one ring fails, the second ring can act as a backup, to keep the network up.
4. Data is transferred in a sequential manner that is bit by bit. Data transmitted, has to pass through each node of the network, till the destination node.

Advantages of Ring Topology

1. Transmitting network is not affected by high traffic or by adding more nodes, as only the nodes having tokens can transmit data.
2. Cheap to install and expand

Disadvantages of Ring Topology

1. Troubleshooting is difficult in ring topology.

2. Adding or deleting the computers disturbs the network activity.
3. Failure of one computer disturbs the whole network.

STAR Topology

In this type of topology all the computers are connected to a single hub through a cable. This hub is the central node and all other nodes are connected to the central node.

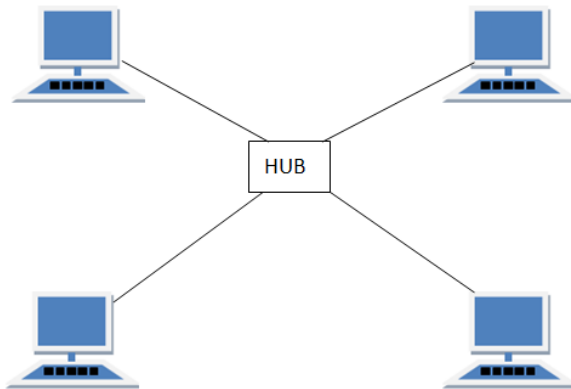

Features of Star Topology

1. Every node has its own dedicated connection to the hub.
2. Hub acts as a repeater for data flow.
3. Can be used with twisted pair, Optical Fibre or coaxial cable.

Advantages of Star Topology

1. Fast performance with few nodes and low network traffic.
2. Hub can be upgraded easily.
3. Easy to troubleshoot.
4. Easy to setup and modify.
5. Only that node is affected which has failed, rest of the nodes can work smoothly.

Disadvantages of Star Topology

1. Cost of installation is high.
2. Expensive to use.
3. If the hub fails then the whole network is stopped because all the nodes depend on the hub.

4. Performance is based on the hub that is it depends on its capacity

MESH Topology

It is a point-to-point connection to other nodes or devices. All the network nodes are connected to each other. Mesh has $\frac{n(n-1)}{2}$ physical channels to link n devices.

There are two techniques to transmit data over the Mesh topology, they are :

1. Routing
2. Flooding

Routing

In routing, the nodes have a routing logic, as per the network requirements. Like routing logic to direct the data to reach the destination using the shortest distance. Or, routing logic which has information about the broken links, and it avoids those node etc. We can even have routing logic, to re-configure the failed nodes.

Flooding

In flooding, the same data is transmitted to all the network nodes, hence no routing logic is required. The network is robust, and the its very unlikely to lose the data. But it leads to unwanted load over the network.

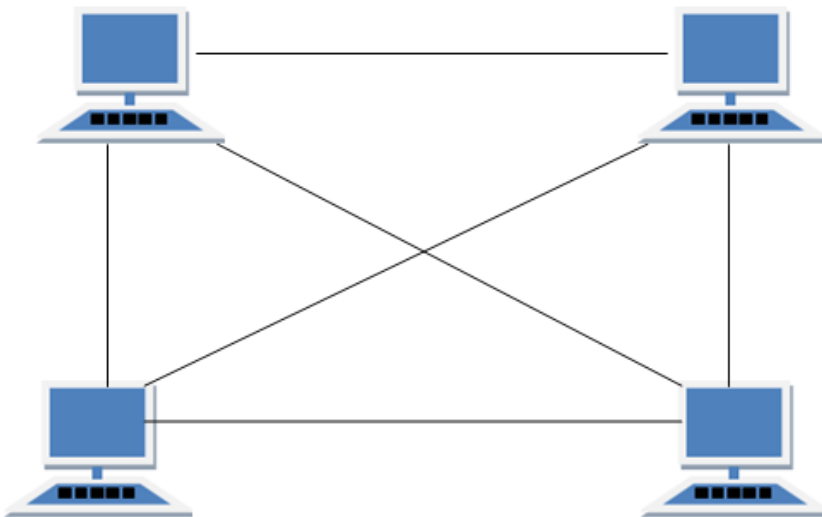

Types of Mesh Topology

1. **Partial Mesh Topology** : In this topology some of the systems are connected in the same fashion as mesh topology but some devices are only connected to two or three devices.
2. **Full Mesh Topology** : Each and every nodes or devices are connected to each other.

Features of Mesh Topology

1. Fully connected.
2. Robust.
3. Not flexible.

Advantages of Mesh Topology

1. Each connection can carry its own data load.
2. It is robust.
3. Fault is diagnosed easily.
4. Provides security and privacy.

Disadvantages of Mesh Topology

1. Installation and configuration is difficult.
2. Cabling cost is more.
3. Bulk wiring is required.

TREE Topology

It has a root node and all other nodes are connected to it forming a hierarchy. It is also called hierarchical topology. It should at least have three levels to the hierarchy.

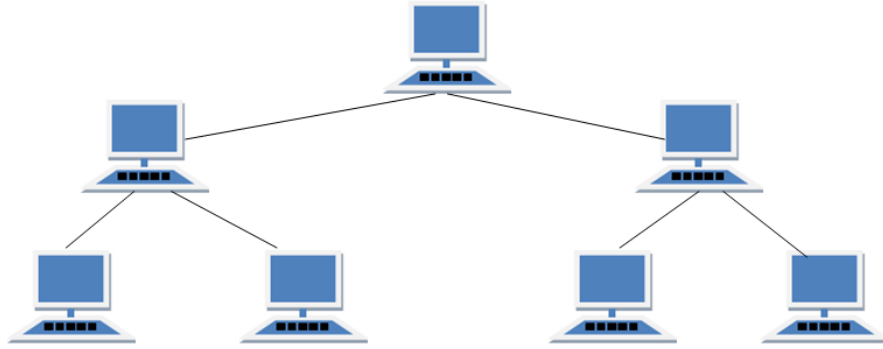

Features of Tree Topology

1. Ideal if workstations are located in groups.
2. Used in Wide Area Network.

Advantages of Tree Topology

1. Extension of bus and star topologies.
2. Expansion of nodes is possible and easy.
3. Easily managed and maintained.
4. Error detection is easily done.

Disadvantages of Tree Topology

1. Heavily cabled.
2. Costly.
3. If more nodes are added maintenance is difficult.
4. Central hub fails, network fails.

HYBRID Topology

It is two different types of topologies which is a mixture of two or more topologies. For example if in an office in one department ring topology is used and in another star topology is used, connecting these topologies will result in Hybrid Topology (ring topology and star topology).

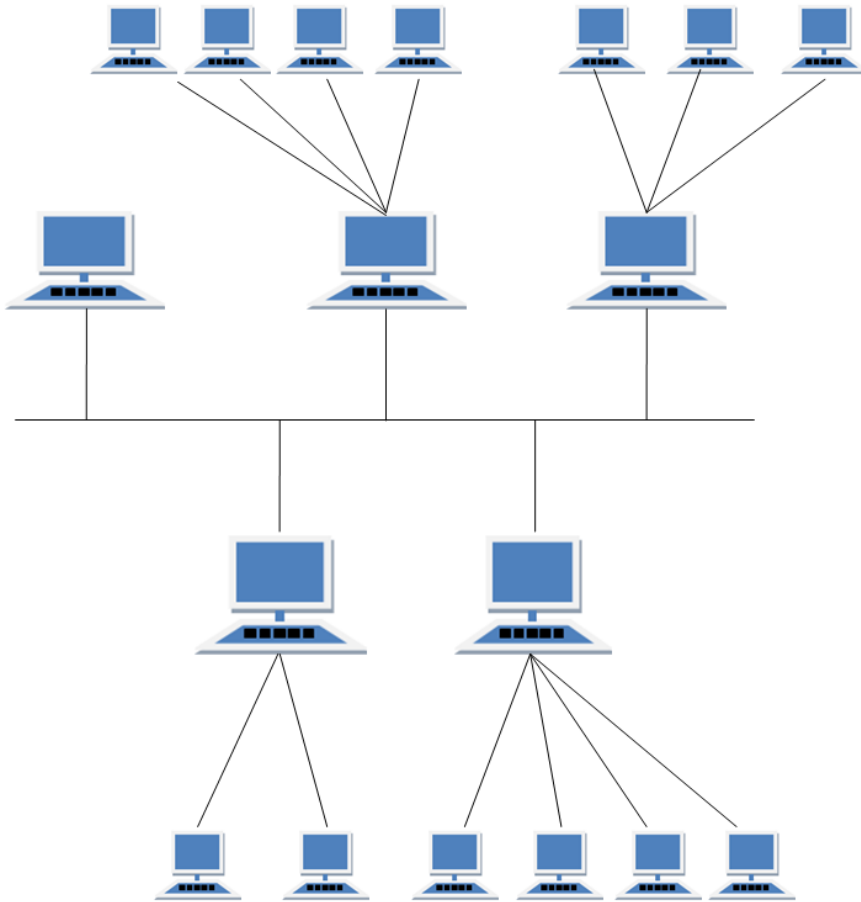

Features of Hybrid Topology

1. It is a combination of two or topologies
2. Inherits the advantages and disadvantages of the topologies included

Advantages of Hybrid Topology

1. Reliable as Error detecting and trouble shooting is easy.
2. Effective.
3. Scalable as size can be increased easily.
4. Flexible.

Disadvantages of Hybrid Topology

1. Complex in design.
2. Costly.

Transmission Modes in Computer Networks

Transmission mode means transferring of data between two devices. It is also called communication mode. These modes direct the direction of flow of information. There are three types of transmission mode. They are :

- Simplex Mode
- Half duplex Mode
- Full duplex Mode

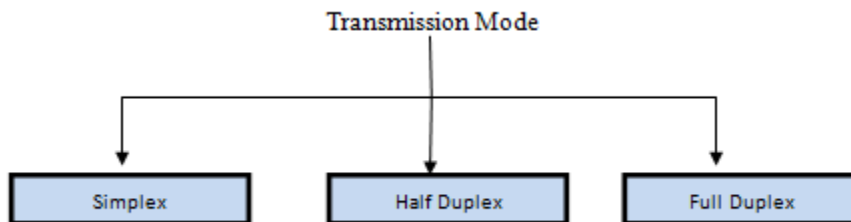

SIMPLEX Mode

In this type of transmission mode data can be sent only through one direction i.e. communication is unidirectional. We cannot send a message back to the sender. Unidirectional communication is done in Simplex Systems.

Examples of simplex Mode is loudspeaker, television broadcasting, television and remote, keyboard and monitor etc.

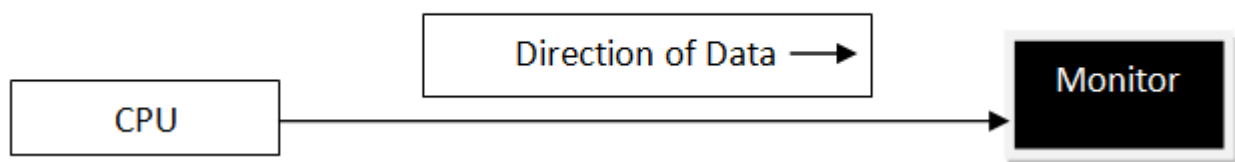

HALF DUPLEX Mode

In half duplex system we can send data in both directions but it is done one at a time that is when the sender is sending the data then at that time we can't send the sender our message. The data is sent in one direction.

Example of half duplex is a walkie- talkie in which message is sent one at a time and messages are sent in both the directions.

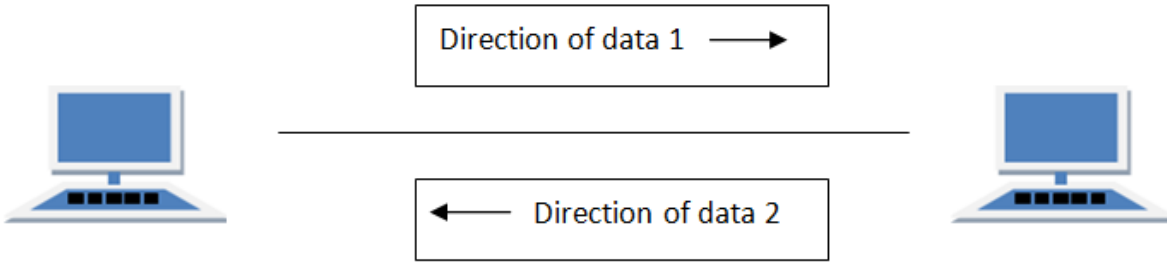

FULL DUPLEX Mode

In full duplex system we can send data in both directions as it is bidirectional. Data can be sent in both directions simultaneously. We can send as well as we receive the data.

Example of Full Duplex is a Telephone Network in which there is communication between two persons by a telephone line, through which both can talk and listen at the same time.

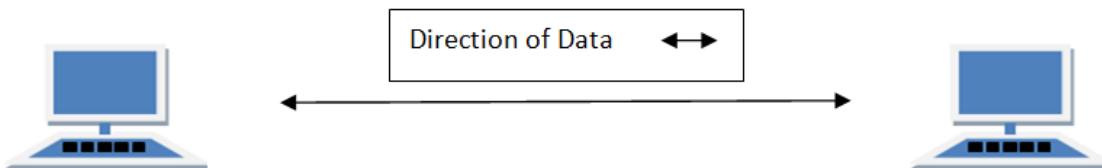

In full duplex system there can be two lines one for sending the data and the other for receiving data.

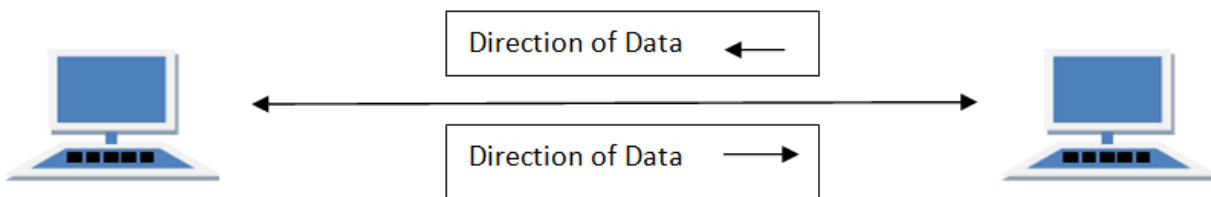

Transmission Mediums in Computer Networks

Data is represented by computers and other telecommunication devices using signals. Signals are transmitted in the form of electromagnetic energy from one device to another. Electromagnetic signals travel through vacuum, air or other transmission mediums to travel between one point to another (from source to receiver).

Electromagnetic energy (includes electrical and magnetic fields) includes power, voice, visible light, radio waves, ultraviolet light, gamma rays etc.

Transmission medium is the means through which we send our data from one place to another. The first layer (physical layer) of Communication Networks OSI Seven layer model is dedicated to the transmission media, we will study the OSI Model later.

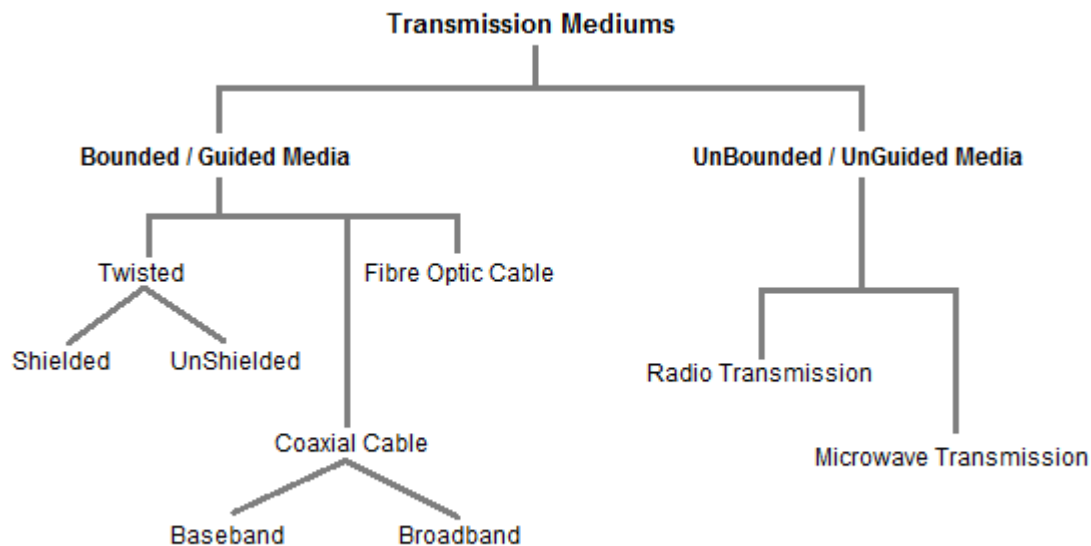

Factors to be considered while choosing Transmission Medium

1. Transmission Rate
2. Cost and Ease of Installation
3. Resistance to Environmental Conditions
4. Distances

Bounded/Guided Transmission Media

It is the transmission media in which signals are confined to a specific path using wire or cable. The types of Bounded/ Guided are discussed below.

Twisted Pair Cable

This cable is the most commonly used and is cheaper than others. It is lightweight, cheap, can be installed easily, and they support many different types of network. Some important points :

- Its frequency range is 0 to 3.5 kHz.
- Typical attenuation is 0.2 dB/Km @ 1kHz.
- Typical delay is 50 μ s/km.
- Repeater spacing is 2km.

Twisted Pair is of two types :

- Unshielded Twisted Pair (UTP)
- Shielded Twisted Pair (STP)

Unshielded Twisted Pair Cable

It is the most common type of telecommunication when compared with Shielded Twisted Pair Cable which consists of two conductors usually copper, each with its own colour plastic insulator. Identification is the reason behind coloured plastic insulation.

UTP cables consist of 2 or 4 pairs of twisted cable. Cable with 2 pair use **RJ-11** connector and 4 pair cable use **RJ-45** connector.

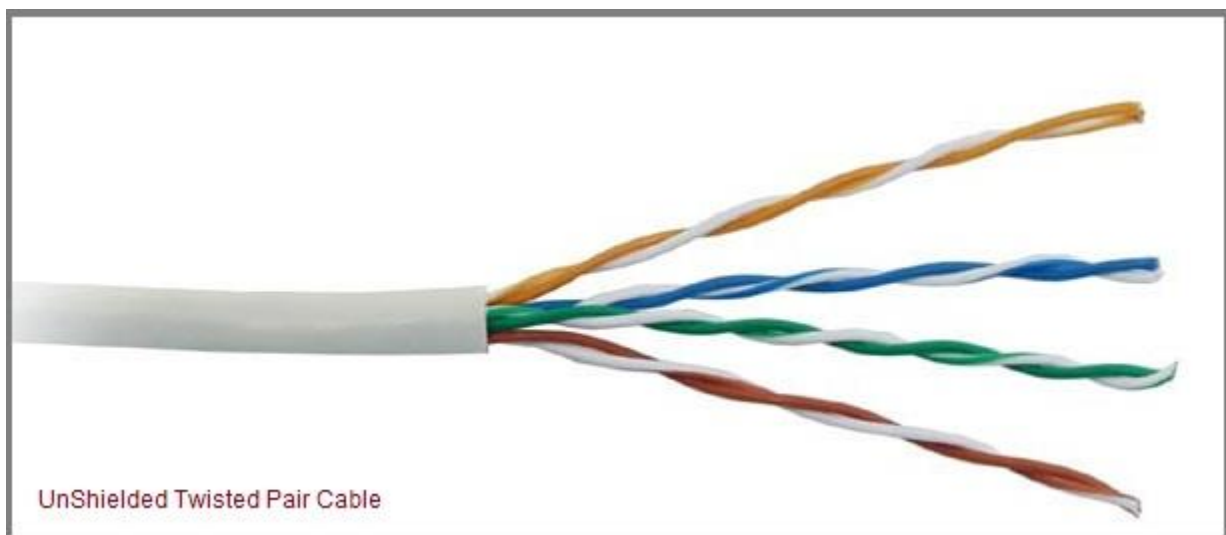

Advantages :

- Installation is easy

- Flexible
- Cheap
- It has high speed capacity,
- 100 meter limit
- Higher grades of UTP are used in LAN technologies like Ethernet.

It consists of two insulating copper wires (1mm thick). The wires are twisted together in a helical form to reduce electrical interference from similar pair.

Disadvantages :

- Bandwidth is low when compared with Coaxial Cable
- Provides less protection from interference.

Shielded Twisted Pair Cable

This cable has a metal foil or braided-mesh covering which encases each pair of insulated conductors. Electromagnetic noise penetration is prevented by metal casing. Shielding also eliminates crosstalk (explained in KEY TERMS Chapter).

It has same attenuation as unshielded twisted pair. It is faster than unshielded and coaxial cable. It is more expensive than coaxial and unshielded twisted pair.



Advantages :

- Easy to install

- Performance is adequate
- Can be used for Analog or Digital transmission
- Increases the signalling rate
- Higher capacity than unshielded twisted pair
- Eliminates crosstalk

Disadvantages :

- Difficult to manufacture
- Heavy

Coaxial Cable

Coaxial is called by this name because it contains two conductors that are parallel to each other. Copper is used in this as centre conductor which can be a solid wire or a standard one. It is surrounded by PVC insulation, a sheath which is encased in an outer conductor of metal foil, braid or both.

Outer metallic wrapping is used as a shield against noise and as the second conductor which completes the circuit. The outer conductor is also encased in an insulating sheath. The outermost part is the plastic cover which protects the whole cable.

Here the most common coaxial standards.

- 50-Ohm RG-7 or RG-11 : used with thick Ethernet.
- 50-Ohm RG-58 : used with thin Ethernet
- 75-Ohm RG-59 : used with cable television
- 93-Ohm RG-62 : used with ARCNET.

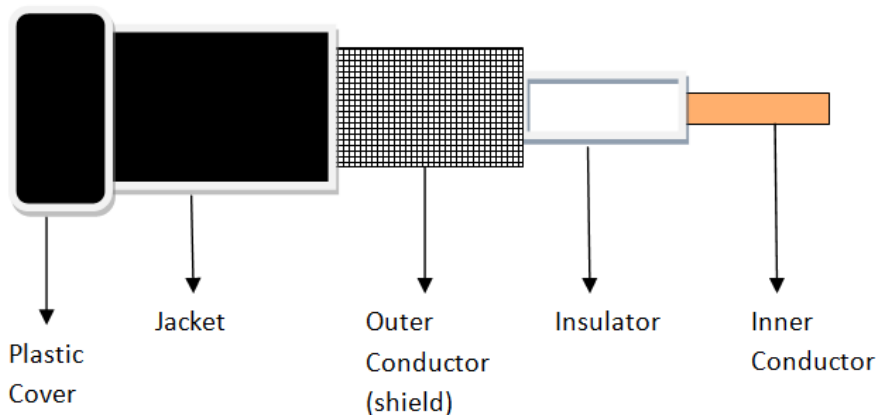

There are two types of Coaxial cables :

BaseBand

This is a 50 ohm (Ω) coaxial cable which is used for digital transmission. It is mostly used for LAN's. Baseband transmits a single signal at a time with very high speed. The major drawback is that it needs amplification after every 1000 feet.

BroadBand

This uses analog transmission on standard cable television cabling. It transmits several simultaneous signal using different frequencies. It covers large area when compared with Baseband Coaxial Cable.

Advantages :

- Bandwidth is high
- Used in long distance telephone lines.
- Transmits digital signals at a very high rate of 10Mbps.
- Much higher noise immunity
- Data transmission without distortion.
- They can span to longer distance at higher speeds as they have better shielding when compared to twisted pair cable

Disadvantages :

- Single cable failure can fail the entire network.
- Difficult to install and expensive when compared with twisted pair.
- If the shield is imperfect, it can lead to grounded loop.

Fiber Optic Cable

These are similar to coaxial cable. It uses electric signals to transmit data. At the centre is the glass core through which light propagates.

In multimode fibres, the core is 50microns, and In single mode fibres, the thickness is 8 to 10 microns.

The core in fiber optic cable is surrounded by glass cladding with lower index of refraction as compared to core to keep all the light in core. This is covered with a thin plastic jacket to protect the cladding. The fibers are grouped together in bundles protected by an outer shield.

Fiber optic cable has bandwidth more than **2 gbps (Gigabytes per Second)**

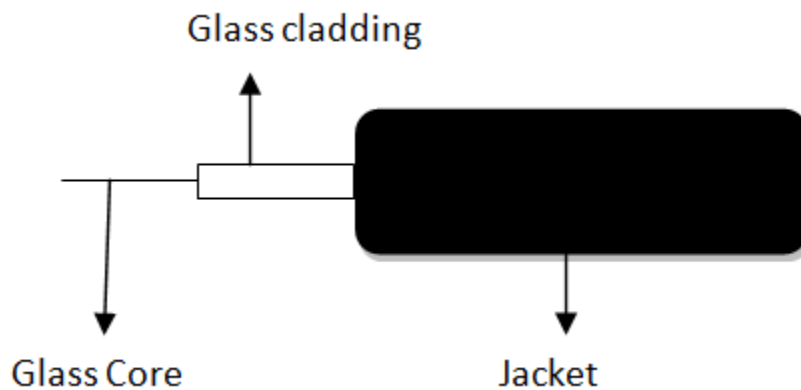

Advantages :

- Provides high quality transmission of signals at very high speed.
- These are not affected by electromagnetic interference, so noise and distortion is very less.
- Used for both analog and digital signals.

Disadvantages :

- It is expensive
- Difficult to install.
- Maintenance is expensive and difficult.
- Do not allow complete routing of light signals.

UnBounded/UnGuided Transmission Media

Unguided or wireless media sends the data through air (or water), which is available to anyone who has a device capable of receiving them. Types of unguided/ unbounded media are discussed below :

- Radio Transmission
- MicroWave Transmission

Radio Transmission

Its frequency is between 10 kHz to 1GHz. It is simple to install and has high attenuation. These waves are used for multicast communications.

Types of Propagation

Radio Transmission utilizes different types of propagation :

- **Troposphere** : The lowest portion of earth's atmosphere extending outward approximately 30 miles from the earth's surface. Clouds, jet planes, wind is found here.
- **Ionosphere** : The layer of the atmosphere above troposphere, but below space. Contains electrically charged particles.

Microwave Transmission

It travels at high frequency than the radio waves. It requires the sender to be inside of the receiver. It operates in a system with a low gigahertz range. It is mostly used for unicast communication.

There are 2 types of Microwave Transmission :

1. Terrestrial Microwave
2. Satellite Microwave

Advantages of Microwave Transmission

- Used for long distance telephone communication
- Carries 1000's of voice channels at the same time

Disadvantages of Microwave Transmission

- It is Very costly

Terrestrial Microwave

For increasing the distance served by terrestrial microwave, repeaters can be installed with each antenna .The signal received by an antenna can be converted into transmittable form and relayed to next antenna as shown in below figure. It is an example of telephone systems all over the world

There are two types of antennas used for terrestrial microwave communication :

1. Parabolic Dish Antenna

In this every line parallel to the line of symmetry reflects off the curve at angles in a way that they intersect at a common point called focus. This antenna is based on geometry of parabola.

2. Horn Antenna

It is a like gigantic scoop. The outgoing transmissions are broadcast up a stem and deflected outward in a series of narrow parallel beams by curved head.

Satellite Microwave

This is a microwave relay station which is placed in outer space. The satellites are launched either by rockets or space shuttles carry them.

These are positioned 3600KM above the equator with an orbit speed that exactly matches the rotation speed of the earth. As the satellite is positioned in a geo-synchronous orbit, it is stationery relative to earth and always stays over the same point on the ground. This is usually done to allow ground stations to aim antenna at a fixed point in the sky.

Features of Satellite Microwave :

- Bandwidth capacity depends on the frequency used.
- Satellite microwave deployment for orbiting satellite is difficult.

Advantages of Satellite Microwave :

- Transmitting station can receive back its own transmission and check whether the satellite has transmitted information correctly.
- A single microwave relay station which is visible from any point.

Disadvantages of Satellite Microwave :

- Satellite manufacturing cost is very high
- Cost of launching satellite is very expensive
- Transmission highly depends on whether conditions, it can go down in bad weather